

Development in the Countryside

Supplementary Guidance SG01

July 2015



Falkirk Council
Development Services

Supplementary Guidance

A suite of supplementary guidance (SGs) is currently being produced by the Council. Most of these SGs are updated versions of previous Supplementary Planning Guidance (SPG) whilst others cover new topic areas (*denotes new SGs). There are 17 SGs in the series, all of which seek to provide more detailed guidance on how particular local development plan policies should be applied in practice.

These SGs form a statutory supplement to the Local Development Plan, and are intended to expand upon planning policies and proposals contained in the proposed plan.

A full list of the supplementary guidance available in this series is found below.

- SG01** **Development in the Countryside ***
- SG02** **Neighbourhood Design**
- SG03** **Residential Extensions and Alterations**
- SG04** **Shopfronts**
- SG05** **Biodiversity and Development**
- SG06** **Trees and Development**
- SG07** **Frontiers of the Roman Empire (Antonine Wall) World Heritage Site**
- SG08** **Local Nature Conservation and Geodiversity Sites ***
- SG09** **Landscape Character Assessment and Landscape Designations ***
- SG10** **Education and New Housing Development**
- SG11** **Healthcare and New Housing Development ***
- SG12** **Affordable Housing**
- SG13** **Open Space and New Development**
- SG14** **Spatial Framework and Guidance for Wind Energy Development**
- SG15** **Low and Zero Carbon Development ***
- SG16** **Listed Buildings and Unlisted Properties in Conservation Areas ***
- SG17** **Renewable Energy ***

Development in the Countryside

1. Introduction



2. Planning Policy Context



3. Housing in the Countryside



4. Business Development in the Countryside



5. Design Guidance



6. Appendices



1. Introduction

- 1.1** This supplementary guidance has been produced by Falkirk Council to elaborate on key countryside policies contained in the Local Development Plan. It provides more detailed guidance to developers and others on matters to take into account when approaching the Council with proposals for development in the countryside, in particular:
- (a) the circumstances in which development in the countryside will be permitted (Sections 3 and 4); and
 - (b) design guidance on new development in the countryside (Section 5).
- 1.2** In all cases it is recommended that pre-application advice is sought from the planning authority. Pre-application advice can be particularly useful in helping identify the issues to be covered and information that will be needed to support a planning application, which in turn can help accelerate the process. It is also advised that applicants seek appropriate professional advice (architect, structural engineer, landscape architect, ecologist etc), particularly where conversion, restoration or replacement of existing buildings in the countryside is involved.

2. Planning Policy Context

National Policy

- 2.1 The national policy framework for rural development is set out in the Scottish Planning Policy (SPP), with additional guidance provided by Planning Advice Note (PAN72): Housing in the Countryside.
- 2.2 The SPP adopts a positive approach to rural areas, with the overarching aim of enabling development which supports prosperous and sustainable communities, whilst protecting and enhancing environmental quality. New development should respond to the specific local circumstances and character of an area.
- 2.3 The focus of PAN72 is set out in key design principles, with the purpose of creating more opportunities for good quality rural housing which respects Scottish landscapes and building traditions. It emphasises the importance of landscape setting and context. If a proper fit in the landscape is not achieved, then even a well designed building can fail. High quality design is seen as integral to new development.



Falkirk Local Development Plan

- 2.4 The Council's objective through the Local Development Plan is to protect the character and environmental quality of Falkirk's countryside whilst facilitating well designed development, in the right places, where it is justified and necessary.
- 2.5 The key Local Development Plan policies to guide new development in the countryside are provided by :

- Policy CG01** **Countryside**
- Policy CG02** **Green Belt**
- Policy CG03** **Housing in the Countryside**
- Policy CG04** **Business Development in the Countryside**

Policy CG01 is a keynote policy which defines 'countryside' as those areas outwith the Urban and Village Limits. The Urban/Village Limits are identified on the Proposals Map of the LDP.

Policy CG02 applies within areas which, as well as being countryside, are also designated as green belt. Within the green belt there is a stronger presumption against development, and more stringent criteria to meet.

- 2.6 This Supplementary Guidance focuses on **Policies CG03** and **CG04** which deal with housing and business. Other types of development commonly promoted in the countryside are covered by other specific topic policies, e.g.

- Policy RW01** **Renewable Energy**
- Policy RW02/03** **Minerals**
- Policy RW08** **Waste Management Facilities**
- Policy INF13** **Telecommunications**

These key policies are supported by a number of general environmental policies which may also apply depending on the individual nature and location of the development proposal (a list of these policies is provided in Appendix 1).

3. Housing in the Countryside

Introduction

- 3.1** The general strategy of the LDP is to direct new housing development in rural areas to the existing villages, in order to sustain their vitality and take advantage of village services and infrastructure. However, it is recognised that there are circumstances where new houses in the countryside are necessary or appropriate.
- 3.2** **Policy CG03** aims both to encourage the sympathetic use of existing traditional buildings of character, as well as ensuring that new houses are located sympathetically and constructed to the highest standards of design and finish. Central to achieving this is harnessing the potential of redundant traditional rural buildings which contribute to the character and quality of the countryside. These buildings represent a significant resource both architecturally and from a sustainability point of view and have the potential to be reused and adapted to help meet present and future rural development needs. However there will be circumstances where new housing is considered acceptable.

- 3.3** **Policy CG03** sets out the circumstances where housing in the countryside will be supported :

Policy CG03 Housing in the Countryside

Proposals for housing development in the countryside of a scale, layout and design suitable for its intended location will be supported in the following circumstances:

1. Housing required for the pursuance of agriculture, horticulture, or forestry, or the management of a business for which a countryside location is essential;
2. Restoration or replacement of houses which are still substantially intact, provided the restored/replacement house is of a comparable size to the original;
3. Conversion or restoration of non-domestic farm buildings to residential use, including the sensitive redevelopment of redundant farm steadings;
4. Appropriate infill development;
5. Limited enabling development to secure the restoration of historic buildings or structures; or
6. Small, privately owned gypsy/traveller sites which comply with Policy HSG08.

Detailed guidance on the application of these criteria will be contained in Supplementary Guidance SG01 'Development in the Countryside'. Proposals will be subject to a rigorous assessment of their impact on the rural environment, having particular regard to policies protecting natural heritage and the historic environment.



3. Housing in the Countryside

Access and Servicing

- 3.4** All proposals will be required to meet the Council's standards for access and servicing. New developments are likely to have an impact on the local and strategic road network through the introduction of new journeys. In some circumstances where there are significant concerns the Council will request a transport assessment to ensure that any impacts on the transport network are identified at an early stage, and appropriate mitigation measures are introduced. Please refer to the Council's 'Design Guidelines & Construction Standards for Roads in the Falkirk Council Area' which can be found on the Council's website (www.falkirk.gov.uk)

Protected Species

- 3.5** Bats and birds can be encountered when redeveloping existing buildings. Some species are protected by law and to disturb them can constitute an offence. It is therefore recommended that an initial check is undertaken to identify if there are any issues which require further investigation. The presence of bats or birds is unlikely to mean that works cannot go ahead but does mean that their presence must be accommodated both during and after works. In these circumstances consultation within the Council or Scottish Natural Heritage (SNH) is essential.
- 3.6** The following supporting information gives further explanation to aid the interpretation of sub sections 1-6 of **Policy CG03**.

3.7 (1) Required to Support an Economic Activity

The Council recognises that the nature of a rural business may mean that managers or employees need to live on site. If a house is required on site for an economic activity all of the following criteria must be met:

- The submission of a business plan to demonstrate that the business has been planned on a sound financial basis and the business is economically viable.
- The submission of a supporting statement to demonstrate that the operational need for the additional house in association with the business.
- Evidence that no existing dwelling which might have served that need has been sold or otherwise alienated from the holding.
- Evidence that there are no reasonable opportunities for reusing or converting redundant buildings rather than building a new dwelling.
- If the above criteria are met, the proposed house will then be assessed in terms of its location, siting and design.

It should be noted that where a house is to be associated with a proposed economic activity, construction of the house will not be permitted in advance of the development of the business. In these circumstances, it is usual for the Council to grant a temporary permission for a non-permanent form of housing pending the establishment of the business.

3. Housing in the Countryside

3.8 (2) Restoration or Replacement of a House

(a) Restoration

The Council wants to encourage the restoration and re-use of worthwhile buildings in the countryside. Restoration rather than replacement will be favoured where the building is of traditional form and construction, is otherwise of architectural or historic merit, makes a positive contribution to the landscape or contributes to local character. The emphasis is on utilising the historic building fabric which already exists in the countryside. In these circumstances all of the following criteria must be met:

- The building, by virtue of its existing character, makes a positive contribution to the rural landscape.
- The building is substantially intact and is capable of beneficial restoration without substantial rebuilding. (Refer to Note 1 on Page 7).
- The restored or converted building is of comparable scale and character to the original building, and utilises natural materials which are locally sourced where possible.



Existing Building Contributes to Local Character

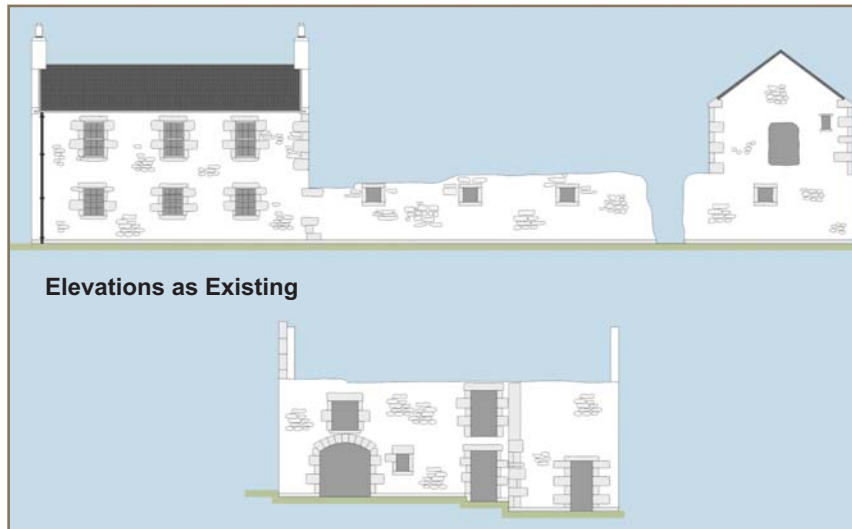

Case Study : Bulliondale House, Avonbridge

Copyright and Credits : The Pollock Hammond Partnership Architects and Conservation Consultants

3. Housing in the Countryside

(b) Replacement

There may be some houses in the countryside that may no longer meet the requirements for modern living, having fallen into a poor state of repair, or have been affected by adverse structural conditions. Such houses may have a dilapidated appearance, detracting from the landscape setting of the countryside and their removal would be beneficial. In the case of a replacement house all of the following criteria must be met:

- The existing house is in a habitable state (i.e. not a ruin).
- The building is of no architectural or historic interest, and makes no contribution to the local landscape.
- Evidence is provided that the existing house is sub-standard and of a design that is not readily improvable or extendable.
- The replacement house is of comparable scale and of high quality design appropriate to its setting and the surrounding area.
- The new house should occupy the same site as the original house, unless it can be demonstrated that an adjacent area provides a better landscape fit, in which case the existing house must be demolished and the land reinstated thereafter. It should be noted that where a building is listed, proposals will firstly have to meet the terms of **Policy D09** Listed Buildings contained within the LDP (Supporting Policies Section).

Note 1. For the purposes of sections (2) and (3) pages 6-8, 'substantially intact' will generally mean that the external walls and gables are still intact and are structurally sound. Applications should be accompanied by a structural engineer's report certifying that the building is capable of conversion without rebuilding the intact sections.



Photograph Copyright : Andrew Lee Photographer
Copyright and Credits : Simon Winstanley Architects

3. Housing in the Countryside

3.9 (3) Conversion or Restoration of non-domestic Farm Buildings/ Redevelopment of Farm Steadings

(a) Conversion or Restoration of non-domestic Farm Buildings

Farm or other non-residential buildings can also offer opportunities for beneficial conversion and re-use as homes. Proposals must meet all of the following criteria:

- The building is no longer required for the purposes it was built.
- The building, by virtue of its existing character, makes a positive contribution to the rural landscape.
- The building is substantially intact and is capable of beneficial restoration. (Refer to Note 1 on Page 7).
- The building is safely accessible and can be linked to water and other services without substantial rebuilding.
- The restored or converted building is of comparable scale and character to the original building and materials used should be sympathetic.



Non-Domestic Farm Buildings Capable of Beneficial Restoration



Case Study : Barn Conversion

Copyright and Credits : Beaton and McMurchy Architects



Converted Farm Steading

3. Housing in the Countryside

(b) Redevelopment of Farm Steadings

Traditional agricultural farm steadings are a significant feature of the Scottish landscape, usually comprising a collection of individual buildings as well as the farmhouse itself formed around a central courtyard area. Changes in agricultural practice have resulted in many buildings becoming redundant. Conversion and redevelopment of farm steadings offers the opportunity to increase the level and variety of Falkirk's housing stock, as well as meeting the needs of rural areas for commercial or industrial development.

Farm steadings are a finite resource and once their character has been eroded or lost, they cannot be replaced and their contribution towards the character of the rural landscape will be diminished. It is therefore important that conversions and redevelopment proposals are undertaken in a sensitive and innovative manner that conserves their original character.

In addition to the criteria set out in 3 (a) for the conversion or restoration of residential and non-residential buildings, proposals for the redevelopment of farm steadings must meet all of the following criteria:

- There must be retention of some of the built elements of the steading.
- Limited new development will be permitted within the steading envelope provided it integrates well with, and does not impact on the character and form of the existing building group.
- The traditional character and form of the existing building group is retained.
- The emphasis is on a coherent design concept which seeks to retain the steading character rather than a collection of 'suburban style' houses.
- The submission of a masterplan will be required.



Farm Steading Converted and Extended to Create a Coherent Building Group



Traditional Character Retained by Redevelopment of Farm Steading

3. Housing in the Countryside

3.10 (4) Infill Development

Appropriate infill development will be allowed between two residential properties where all of the following criteria are met :

- The proposed infill development must occupy a clear gap between two existing residential properties.
- The scale, density and design of the proposed infill housing should respect the character of existing development. Proposals should respond to local distinctiveness.
- The existing residential properties must front a road or access lane and be less than 80 metres apart.
- The gap is not on the edge of an existing village or urban limit where the edge of the settlement has already been defined.
- The development should not constitute ribbon or backland development. (Ribbon development is defined as the outward linear growth of development along a road).
- If there is a predominant building line this should be adhered to.
- The terms of LDP **Policy HSG05** (Infill Development and Subdivision of Plots) should be met.

3.11 Figure 1:
Examples of unacceptable and acceptable infill development

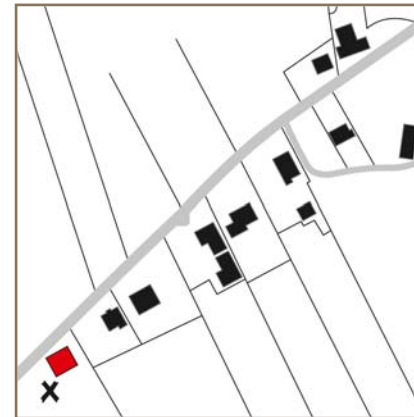

Inappropriate
Ribbon Development

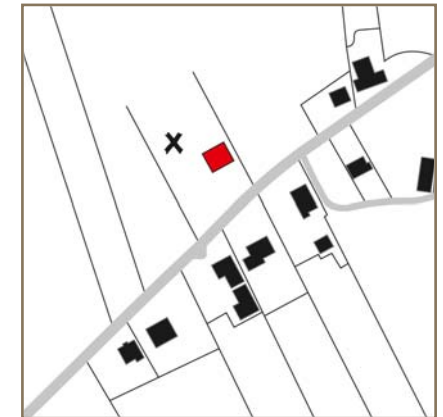

Inappropriate
Sporadic Development



Inappropriate
Backland Development



Appropriate
Infill Development

3. Housing in the Countryside

3.12 (5) Enabling Development

Enabling development may be permitted in some circumstances where it will secure the long term future of historic buildings or historic assets. This is development that would not normally be acceptable in general policy terms, but can be justified where there are overriding conservation benefits to be gained from the overall development scheme, which could not be achieved through other means. It would typically seek to subsidise the cost of major repair or conversion to a viable use of a significant historic building or historic asset.



Larbert House :
Approved Enabling Development Scheme to support restoration, conversion and extension of Category “B” Listed Mansion

Proposals involving enabling development will only be permitted where all of the following criteria can be met :

- The enabling development will secure the restoration, re-use and long-term future of an historic building or structure of acknowledged importance.
- The conservation benefits significantly outweigh the disbenefits of setting aside the normal presumption against development in the countryside.
- The design, materials, massing, location and density of the enabling development does not compromise the special character or historic setting of the principal restoration development, its relationship to ancillary historic buildings and structures, and any associated designed landscape, with particular reference to **LDP Policies D09** (Listed Buildings) and **D12** (Historic Gardens and Designed Landscapes).
- The submission of a Statement of Justification, which includes sufficient detailed financial information to allow the proposal to be fully assessed.
- The Statement of Justification should demonstrate that :
 - The principal restoration development would be financially unviable without the enabling development due to a demonstrable level of conservation deficit. All other potential sources of subsidy have been explored, and the property or asset has been subjected to appropriate marketing.
 - The scale of enabling development is the minimum necessary to secure the long term future of the principal restoration development, whilst allowing an appropriate level of developer profit.

3. Housing in the Countryside

3.13 (6) Gypsy/Travellers

Gypsies and Travellers have specific housing needs, requiring sites for caravans and mobile homes, which are difficult to locate within urban areas. The SPP requires authorities to set out policies for dealing with applications for small privately owned sites.

Proposals for small privately owned sites to accommodate gypsy/travellers should not impact negatively on the surrounding countryside. Proposals will be permitted where they comply with **Policy HSG08** Gypsy/Travellers' Sites which requires that :

- The site satisfies policies in the LDP relating to the protection of the built and the natural heritage (**Policies GN02-05** and **D07-14**) and the protection of the public open space (**Policy INF03**).
- The site can be appropriately landscaped, such that there will be no adverse effect on the character, appearance and amenity of the area.
- The site affords an appropriate level of residential amenity and access to community facilities; and
- Access, parking and other servicing can be provided to a satisfactory standard, and the site is not at significant risk from flooding, in terms of LDP **Policy RW06** - Flooding.

4. Business Development in the Countryside

- 4.1 The Council wishes to promote sustainable economic activity in rural areas. Rural sites may offer various opportunities for economic growth. Farm diversification, the re-use of rural buildings and appropriate redevelopment and expansion proposals for existing industrial and business purposes will generally offer the greatest scope for sustainable economic development in the countryside. However new businesses may arise where there is a site specific resource opportunity.
- 4.2 The countryside provides a setting for many leisure activities. These include both informal pursuits and organised sports, with a range of requirements in terms of infrastructure and facilities. Countryside recreation can provide much needed economic activity in the rural area, as well as promoting the enjoyment of the area's natural heritage. At the same time, a cautious approach is necessary as some activities have implications for the character of the countryside, in terms of visual, ecological and noise impacts which need to be carefully assessed.



Farm Diversification at Wellsfield Farm Equestrian Centre

- 4.3 Policy CG04 sets out the circumstances where business development will be supported :

Policy CG04 Business Development in the Countryside

Proposals for business development in the countryside of a scale, layout and design suitable for its intended location will be supported in the following circumstances:

1. Areas specifically identified for business development on the Proposals Map;
2. Business development, including appropriate leisure and tourism uses, where a need for a countryside location is demonstrated, or the development constitutes an appropriate form of farm diversification;
3. Proposals involving the re-use of industrial, commercial or institutional land or premises, or the conversion of farm buildings for business use; or
4. Limited extensions to existing established business in the countryside;

Detailed guidance on the application of these criteria will be contained in Supplementary Guidance SG01 'Development in the Countryside'. Proposals will be subject to a rigorous assessment of their impact on the rural environment, having particular regard to policies protecting natural heritage and the historic environment.

Access and Servicing

- 4.4 All proposals will be required to meet the Council's standards for access and servicing. New developments are likely to have an impact on the local and strategic road network through the introduction of new journeys. In some circumstances where there are significant concerns the Council will request a transport assessment to ensure that any impacts on the transport network are identified at an early stage, and appropriate mitigation measures are introduced. Please refer to the Council's 'Design Guidelines & Construction Standards for Roads in the Falkirk Council Area' which can be found on the Council's website (www.falkirk.gov.uk)

4. Business Development in the Countryside

Protected Species

- 4.5** Bats and birds can be encountered when redeveloping existing buildings. Some species are protected by law and to disturb them can constitute an offence. It is therefore recommended that an initial check is undertaken to identify if there are any issues which require further investigation. The presence of bats or birds is unlikely to mean that works cannot go ahead but does mean that their presence must be accommodated both during and after works. In these circumstances consultation within the Council or Scottish Natural Heritage (SNH) is essential.
- 4.6** The following supporting information gives further explanation to aid the interpretation of sub sections 1-4 of **Policy CG04**.
- 4.7 (1) Areas Identified for Business Development**
There are a few areas specifically identified outwith settlements in the LDP for business development, either as specific economic development proposals or as core business areas. Development within these areas will be subject to the relevant site specific policies and criteria contained in the LDP.



The Kelpies in the Helix Park

4.8 (2) New Business Development

Within the countryside, new business development will generally only be permitted where the need for a countryside location is demonstrated, or the proposal is an appropriate form of farm diversification. All proposals will be subject to a rigorous assessment of their impact on the rural environment.

Tourism is one of the developing sectors in the Falkirk Council area and is recognised in a number of the Council's initiatives and strategies. Appropriate countryside tourism and leisure uses that require a rural location are therefore welcomed in the countryside. The LDP outlines that priority will be given to the development of tourism proposals which support the themes/networks and strategic nodes identified in the plan. The themes are focused around the Central Scotland Green Network, the Canal Network (Forth & Clyde and Union Canals), and the Antonine Wall which intersect at various tourism nodes highlighted below, some of which are in the countryside:

Tourism Nodes

**Falkirk Town Centre,
Bo'ness Town Centre/Harbour/Steam Railway,
Callendar House/Park/Wood,
Helix/Falkirk Gateway,
Falkirk Wheel/Portdownie/Roughcastle,
Gilston/Whitecross, Kinneil, Muiravonside.**

Falkirk's strength in outdoor attractions and activities is being enhanced by projects such as the Helix, the John Muir Way and the World Heritage status of the Antonine Wall. All of these projects will provide opportunities to further enhance Falkirk's status as a tourist location and encourage more visitors to come and stay in the area for a longer period.

4. Business Development in the Countryside



Kingsbarn Equestrian Centre, Shieldhill



The Milk Barn Ice Cream Parlour, Glen Village

Farm diversification into non-agricultural activities can be vital to the continuing viability of many farm enterprises. Not only can diversification help sustain the rural economy, it can provide much needed additional facilities and services for local communities. Diversification should not however result in excessive expansion and encroachment of building development into the countryside, creating problems such as access congestion, noise pollution and loss of amenity. Ideally diversification schemes should remain additional to the main agricultural function of the land, and agriculture should remain the dominant land use in order to preserve landscapes that have resulted from farming activity.

Proposals for new business development will be permitted where the following criteria are met:

- The submission of a Statement of Justification, which includes sufficient detailed financial information to allow the proposal to be fully assessed.
- The Statement of Justification should demonstrate that
 - A countryside location is essential and how the proposal would benefit the local economy.
 - A business plan demonstrating the viability of the proposal in the long term which includes financial projections. (Guidance on producing a business plan and what it should contain can be found on the Business Gateway site.
<http://www.bgateway.com/starting-up/create-business-plan/prepare-a-business-plan/>
- The siting and scale of the proposal and associated infrastructure is appropriate, and design is of a high standard, allowing the development to integrate well into the landscape.
- Proposals for new visitor attractions and tourism infrastructure should support the themes set out in the LDP and the tourism strategies of the Council, thereby enhancing the image and tourism profile of the area.
- Proposals for new hotels, B&B's, guest houses, pubs/restaurants will generally only be permitted where a specific opportunity is identified in the LDP or existing buildings are being utilised. Small-scale proposals for new-build self-catering accommodation, caravan or camping sites may be supported subject to appropriate siting and a high quality of design.

4. Business Development in the Countryside

4.9 (3) Brownfield Land/Conversion of Rural Buildings

(a) Brownfield Land

The policy allows for business proposals which reuse vacant industrial / commercial / institutional land or premises (essentially brownfield land i.e. land that has been previously developed). Usually these sites have been significantly degraded by a former activity. When such sites fall into disuse or are abandoned they have the potential to detract seriously from the visual and environmental amenity of a rural area. This policy recognises that their redevelopment could serve to enhance landscape quality by reducing the physical mass and presence of intrusive buildings within the countryside and simultaneously provide an opportunity to clean up contaminated land and assist environmental, social and economic regeneration. It could also make the best use of existing infrastructure and services and relieve the pressure to build on greenfield land, thus helping to protect the character of the countryside.

Proposals involving the re-use of industrial, commercial or institutional land or premises will require to meet all of the following criteria:

- There are significant environmental and/or community benefits to be gained as a consequence of the vacant site/buildings being re-developed.
- The scale of new development should be dictated by the available brownfield land, the needs of the business, and the capacity of the environment to accept it.
- The siting and scale of the proposal and associated infrastructure is appropriate, and the design is of a high standard, allowing the development to integrate well into the landscape.

(b) Conversion of Farm Buildings

The conversion of existing farm buildings for new business uses will be supported providing the proposal is compatible with surrounding uses.



A typical vernacular farm building

4. Business Development in the Countryside

4.10 (4) Extensions

Proposals for the expansion of an established economic development use in the countryside will be permitted in the following circumstances:

- The scale and nature of the proposal would not impact on the surrounding rural character.
- Where it is not possible to utilise existing buildings, new buildings would need to be in proportion with existing development and integrate well as part of the overall development.
- Where appropriate, proposals should respect scale design and materials of existing buildings.
- Appropriate landscaping measures are introduced which will help aid integration into the landscape.



Beancross Farm Hotel and Restaurant



Conversion and extension of farm steading

4. Business Development in the Countryside

Prior Approval Notification

- 4.11 It should be noted that certain agricultural buildings and operations do not require formal planning permission. Developments involving agriculture will normally require an approval from the planning authority known as Prior Approval Notification to be submitted. This is a quicker procedure than planning permission but still allows the planning authority to raise concerns with the siting, design and external appearance of a building.

5. Design Guidance

Introduction

- 5.1 This design guidance aims to promote a sensitive and imaginative approach to new development in Falkirk's countryside to create a sense of place and maintain local distinctiveness.
- 5.2 New development should respond to the unique character of the area's countryside. This guidance therefore includes overviews of local landscape character and rural building types.
- 5.3 A key objective is to inspire development which is “distinctive, safe and pleasant, welcoming, resource efficient, adaptable, and easy to get around.” These 6 qualities of successful places are set out in the Scottish Government's Policy Statement, “Designing Places.”
- 5.4 PAN 72 provides advice on best practice in terms of design of rural housing which respects the Scottish countryside. Inspirational design forms part of the Scottish Government's agenda to promote good quality housing design and placemaking throughout Scotland.



Copyright and Credits : Colin Smith & Judith Wilson Architects

5. Design Guidance

Distinctive Local Character

5.5 (a) Landscape Character

This design guidance is intended to encourage high quality, contemporary design which reflects local character. To achieve this, developers and their agents require a proper understanding of Falkirk's countryside.

5.6 The Falkirk Council area contains a rich diversity of landscapes variously shaped by geology, climate, historical settlement patterns, variations in types of land use and buildings. They include the flat carselands adjacent to the Forth Estuary to the north, the river valleys of the Carron and the Bonny Water in the central area, the undulating Slamannan plateau to the south, the Denny hills to the east and the rolling farmland of the east, bisected by the scenic Avon Valley.

5.7 These varied landscapes are populated by single houses, country estates, groups of houses, industrial premises and agricultural buildings, the best of which are well sited and are of a scale and design to complement their countryside setting. Inappropriate development in rural areas has a significant detrimental impact, which can affect a large area since many buildings in the countryside can be viewed from a long distance away.

5.8 Supplementary Guidance (SG09) on Landscape Character Assessment and Landscape Designations sets out key information and guidelines based on 16 Landscape Character Areas (LCA's) contained within 6 generic Landscape Character Types that cover the Falkirk Council area. Information includes details on key characteristics, likely future forces for change, sensitivities and guidelines. It is recommended, therefore, that applicants make reference to the appropriate section within SG09 prior to developing preliminary proposals for development in any of the countryside areas.

5.9 The location of new development in any of the 16 LCAs must take into account all factors highlighted in SG09 to ensure that location and design enhance positive attributes of the landscape and meet key aims and objectives.

Generic Landscape Character Types

1. Lowland Hills

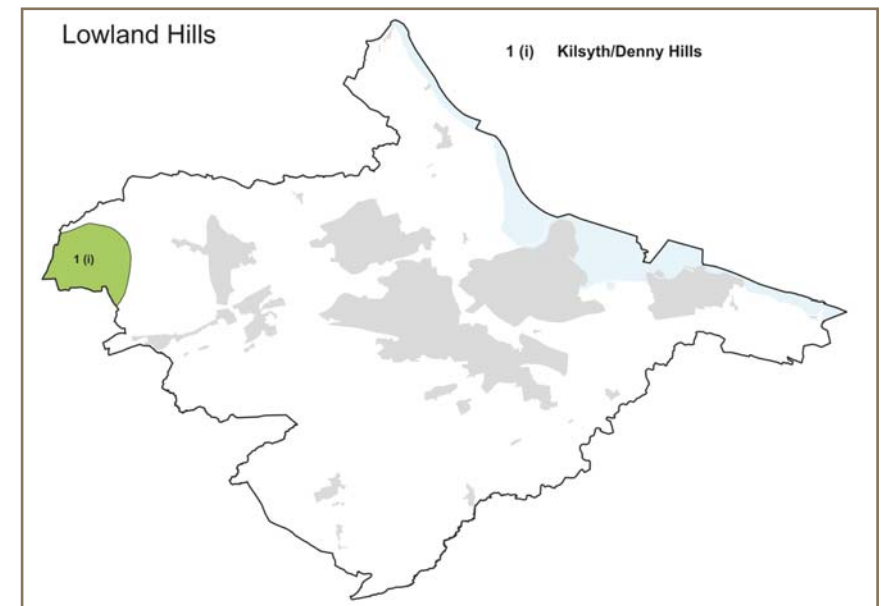

A landscape of lowland hill character, of medium to large scale, open or semi-open, and forming the eastern end of the Campsie Fells / Kilsyth Hills. It has a sense of naturalness, remoteness and wildness, contrasting strongly with the farming and development of lowland areas to the east. Hill tops are moorland with commercial forestry on upper slopes. The enclosure pattern comprises fences and stone walls and a general lack of hedgerows and hedgerow trees. The area is sparsely settled and development is limited to a few farms. Distant views down the Forth Valley to the east are obtained from the area.

5. Design Guidance

2. Lowland Hill Fringes

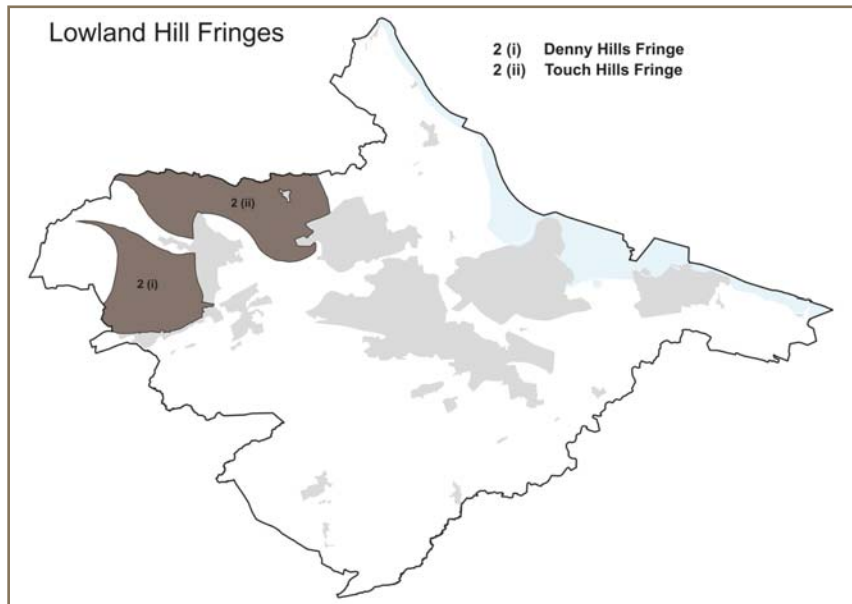

A transitional landscape, between the Lowland River Valleys and the higher ground of the Lowland Hills. It is of small to medium scale, with an intimate mosaic of woodland and farmland with rough and semi-improved grassland on higher ground grading into improved pasture and arable land on lower ground. Woodland cover varies from commercial plantations to small areas of broadleaf woodland. Enclosure ranges from stone walls and fences on higher ground to maintained hedges and hedgerow trees on lower ground. The area is traversed by a network of minor roads, generally on the lower ridges, and includes parts of the main transport corridors, outlying dwellings, farms, small settlements and power lines. There are extensive views out from the higher ground of the area.

3. Lowland Plateaux

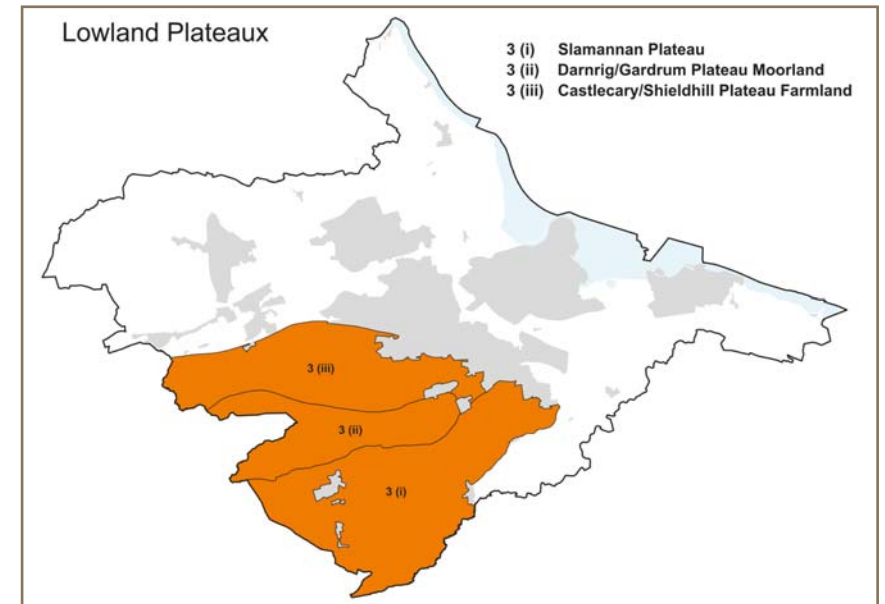

An elevated, gently undulating plateau landscape which rises southwards from the settled Lowland River Valleys. It is predominantly open, often featureless with raised/intermediate bog, wetland and waterbodies. Landcover is conifer plantation, shelterbelts, mixed woodland and generally rough grazing land with some improved land. The area is covered by a network of minor roads and 'B' roads with some medium sized former mining villages, sattered rural dwellings and farms. The area contains evidence of restored former mine workings, some former industrial buildings, peat workings and quarries and transmission towers and power lines are conspicuous. The enclosure pattern comprises fences, stones walls, maintained/unmaintained hedges and boundary trees. There are extensive views across the Forth from the northern edge.

4. Lowland River Valleys

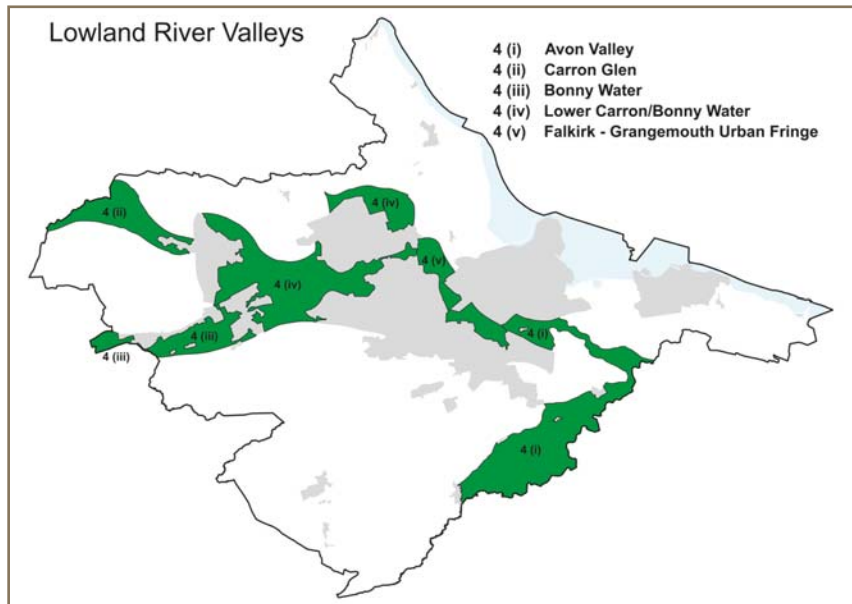

A landscape of broad flat valleys and narrow river valleys containing the Rivers Carron, Avon and Bonny Water; the narrow valleys are steep sided and wooded. The Carron Glen to the west is sparsely populated and is of a strong rural character. The Avon Glen to the south east is more settled by outlying dwellings and farms but retains a rural character. The main settlements and transport corridors occupy these valleys elsewhere and this landscape is generally dominated by development running from Banknock in the west to Polmont in the east. Within the more densely settled area, there is some land of more rural character with a mix of arable land, pasture, mixed woodland, recreational land with a paths network and unmaintained / derelict urban fringe land; some of these areas are designated as Green Belt. Views out of the area are often more limited by built development and woodland.

5. Rolling Farmlands

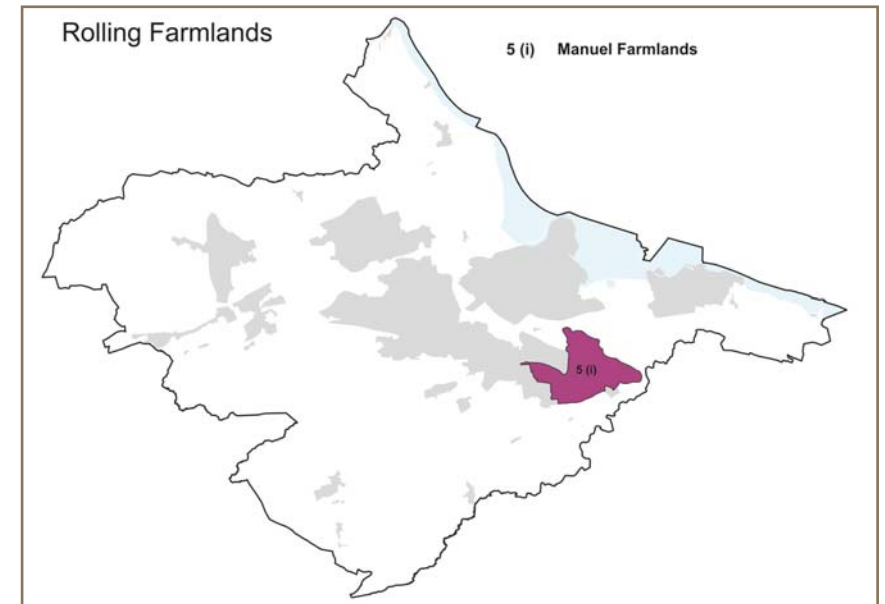

A landscape of smoothly rolling landform of small to medium scale, which has been previously worked in parts for industry (brickworks). Land rises from north and east and westwards towards Polmont. Estate woodland, avenues, mixed woodland and arable land are the main land cover. Farms, estate houses and scattered outlying dwellings form the main settlement pattern, with hedges plus hedgerow trees, fences and walls forming the enclosure pattern. Some longer views out of the area are obtained from high points.

5. Design Guidance

6. Coastal Margins

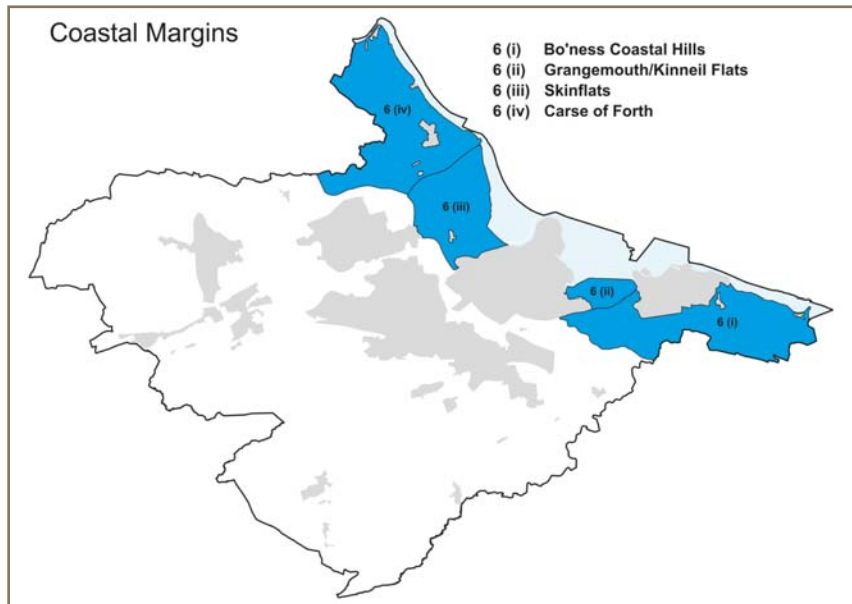

A landscape running along the Firth of Forth and influenced by it, including inter-tidal mudflats, low lying carseland, designed landscapes with woodland, areas of built development and rolling coastal hills (latter to the south of Bo'ness). It contains internationally important habitats and both undeveloped coast and developed coast. The area contains the main arable and mixed farming areas of Falkirk Council area. This landscape contains small settlements (Airth, Letham, Skinflats) with farms and outlying rural dwellings along with important transport corridors; development is very visible in the open areas without woodland cover. The enclosure pattern ranges from only fences on the carseland with no tree cover, to areas with hedges and hedgerow trees on the Bo'ness Coastal Hills. There are long views outwards from the area towards the Forth.

5. Design Guidance

5.10 (b) Buildings in the Countryside

The countryside area of Falkirk has a unique built heritage, reflecting its long settlement history and its strategic location at the heart of central Scotland. It has long been a rich and important agricultural area, hosting the huge Tryst cattle market in former times, and was changed dramatically by the industrial revolution. The legacy of this history is seen today in tower houses, dovecots, castles, large country mansions set in designed landscapes, estate villages, modest farmhouses, miners' cottages, and industrial buildings and structures such as canals, aquaducts, viaducts, bridges and mills.

5.11 Many of these buildings and structures have been designated listed buildings on the basis of their architectural or historic interest. Notable examples include Avondale House, Lathallan House, Torwood Castle, Kinnaird House and Dunmore Estate (including the Pineapple, an outstanding idiosyncratic folly built c 1776 by the 4th Earl of Dunmore whose family provided Dunmore Model village for estate workers in the mid 19th century).

5.12 The distinctive local character of buildings in the countryside is derived from a combination of factors including fit with context, materials and design. From the simple but robust buildings associated with farm steadings to ornamented cottages in estate villages and formal country mansions in landscaped estates, there is a design vigour and strength of character which sets a quality standard for new development to emulate.



Kinningars Park Dovecot a Category "B" Listed Building



Torwood Castle a Category "A" Listed Building

5. Design Guidance



Storage Huts, Causewayend



Typical Farm Steading



Case Study : Cottage Extension
Copyright and Credits : A449 Ltd



Typical vernacular farm buildings

5. Design Guidance

5.13 (c) Villages and Building Clusters

The layout and building styles of the area's small rural settlements reflect their varying origins and histories. Two particularly distinctive types which are of architectural or social significance are the estate village and the miners' row.

5.14 Dunmore and Muirhouses are examples of estate villages. Dunmore was built by the Earl of Dunmore in the 19th century as a model village for estate workers, comprising pretty one and two storey semi-detached houses and terraced cottages arranged around a central green. Key features include pedimented bays and dormers, sandstone walls, slated roofs, overhanging purlinned eaves, finials and ridge ventilators. Muirhouses, to the east of Bo'ness is a settlement of attractive mid nineteenth century estate workers houses, designed in the cottage ornee style with decorative detailing to porches, roofs and windows.

5.15 Coal and fireclay mines once covered the Falkirk landscape, and small groups of miners' cottages grew up adjacent to the collieries. Letham is one of the few examples of a community exclusively based around a colliery. The mine commenced operation in 1912 and Letham Cottages, immediately to the south, was built the following year, the last complete example of a miners' row in the district. Letham Terraces, on the northern side of the colliery, was built circa 1923. Carron Company owned and built the mine, the houses and the railway which supplied coal to its world famous iron foundry.



Moss Cottages a Category "B" Listed Range of terraced cottages arranged around a central green in Dunmore Conservation Area



Entrance Detail : Muirhouses Conservation Area

5. Design Guidance

5.16 (d) Farm Steadings

Due to the diversity of Falkirk's countryside, the siting of farm steadings within the Council area varies according to landscape character. Siting can range from nestling against hill slopes to straddling hill tops and sitting prominently on wide plains. In general terms, farm steadings comprise a tight grouping of small to medium scale ancillary buildings, sheds and barns arranged around a farmhouse to form a courtyard.

5.17 Some of the older farmhouses dating back to the late 17th and early 18th century have been listed for their architectural and historic character.

5.18 Traditionally farm steadings comprised a mix of one and two storey buildings with regular fenestration patterns, generally with a low window to wall ratio and short gables in keeping with lowland farm building traditions. Horse driven engine houses known as horse "gangs" feature on some older steadings, consisting of a separate circular unit with conical roof; they are generally attached to cart bays and barns.



Typical Farm Steading :
Simple arrangement of compact buildings set around a courtyard



Letham Conservation Village



Typical Farmhouse :
Mix of one and two storey buildings with regular fenestration pattern

5. Design Guidance

5.19 External finishes consist of unpainted natural sandstone to walls, with random rubble to barns and other outbuildings and coursed ashlar to the main elevation of the farm house. Although not a dominant feature of the area, some farm buildings also have harling or render with a lime wash finish. Roof coverings range from natural slate and pantiles to pre-formed industrial metals on more modern outbuildings.

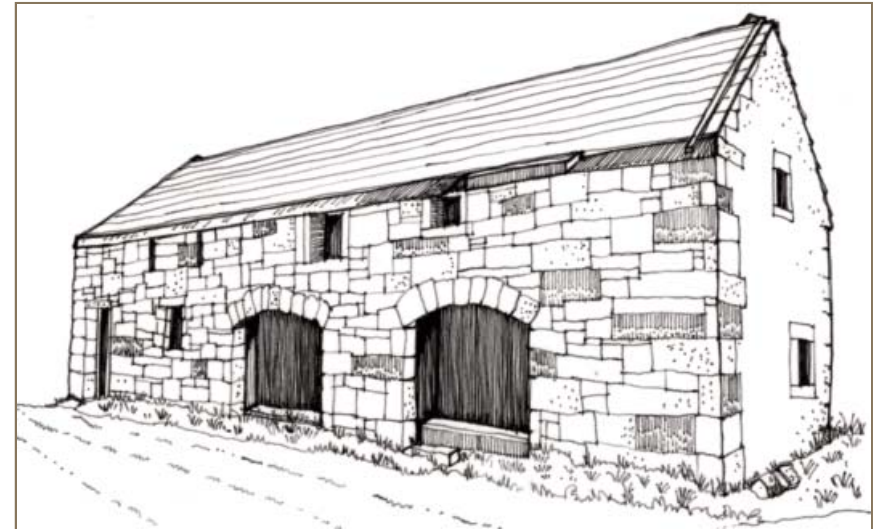

Cart bays with sandstone detailing to front elevation



Typical dormer detail

5. Design Guidance

5.20 (e) Buildings and Country Estates

The area was once peppered with country estates, the remnants of which are still in evidence. Typically, the components of the estate would be a large house set in the midst of a wooded estate with designed elements such as parkland, ornamental loch and ha-ha ditches. Lodge houses sit at driveway entrances. Stables and walled gardens are further common built elements. Many country houses in rural Falkirk have been designated as listed buildings by Historic Scotland on the basis of their architectural or historic interest. Some examples are described below.

5.21 Avondale House is a 16th century mansion with an 18th century 'gothic' symmetrical plan and elevation with pinnacled turrets and battlements. It is surrounded by expansive grounds containing a sizeable stable block designed to complement the main building at the main entry point.

5.22 Larbert House, built in 1822 and designed by David Hamilton was a grand Georgian mansion with "ornate" tower, curved linking loggia and portecochere". It was extended by later Victorian additions and was set within designed landscaped grounds which included a pond, walled garden and stable block.



Avondale House a Category "B" Listed Building



Door Detail : Avondale House

5. Design Guidance

- 5.23** Dunmore Park is included in the Inventory of Gardens and Designed Landscapes owing to the significance of the surviving historic landscaped setting; while the grand mansion of Dunmore Park, 1820 - 1822 is now ruinous, the surviving Pineapple is an outstanding, idiosyncratic architectural folly linked with the walled garden and pavilion.
- 5.24** Lathallan House, designed in the Tudor style by Thomas Hamilton, was constructed 1826 - 1828 with a late 19th century wing; the policies of the estate include a Walled Garden, Ivy Cottage and Power House .



The Pineapple in Dunmore Park a Category "A" Listed Building



Window Detail : Lathallan House



Lathallan House a Category "B" Listed Building

5. Design Guidance

5.25 (f) Traditional Industrial Buildings and Structures

Traditional Industrial and commercial buildings and structures in the countryside include mills, canal side inns, viaducts and aquaducts for water bourne and rail transport networks.



5. Design Guidance

5.26 (g) Modern Buildings in the Rural Landscape

The diversity of contemporary buildings in Falkirk's countryside reflects the prevailing mix of land uses and settlement patterns. Individual houses vary in scale and massing from single storey bungalows to large modern villas; riding stables, chalets, holiday homes, agricultural buildings and premises for light industry are scattered across the landscape.

5.27 Design issues arising from contemporary development include inappropriate scale, massing, urban layout patterns, over-prominent locations and urban architectural style, all of which fail to reflect the rural context. The application of ubiquitous finishes such as concrete roof tiles, metal cladding to large sheds for agricultural buildings and light industry and artificial stone, render, upvc windows and other ancillary fittings to housing has a negative impact by failing to reflect local distinctiveness and rural character. Traditionally, rural buildings were finished in stone, slate, timber, lime wash and lime harling, all naturally sourced materials which help to connect built forms to the landscape.

5.28 More successful modern landmark buildings in the countryside include The Falkirk Wheel, 2001, a groundbreaking feat of engineering designed as the eye catching centrepiece of a major infrastructure project linking the Forth and Clyde and Union Canals. The Helix, is a major infrastructure project to create a new canal link, a lagoon for sport and leisure use and a large recreational parkland featuring the Kelpies, a distinctive public art sculpture of two horses heads straddling the new canal link.



Inappropriate scale



Inappropriate architectural style, scale and location on hilltop setting



Inappropriate urban architectural style and materials

5. Design Guidance

Design Principles for New Development

5.29 (a) Location

National planning policy and guidance emphasises the importance of fit and design of new development in the landscape. These considerations are key to making development acceptable. The general parameters as set out below are aimed at encouraging high quality, individual design that is sensitive both to its immediate setting but also defines the characteristics of the wider local area.

- 5.30 Large new buildings, including those associated with agriculture and leisure should be sited to minimise visibility from public roads, popular walking routes and areas of informal and formal public recreation.
- 5.31 Wooded sites and trees can provide a pleasing backdrop to new developments in the countryside whilst effecting a level of amalgamation into the landscape at the same time.
- 5.32 New development should integrate with and take advantage of existing features of the landscape or the site including topography, trees, woodlands, water features, existing buildings and boundary treatments. New development should 'nestle' within the landscape.



Housing integrating into the existing landscape

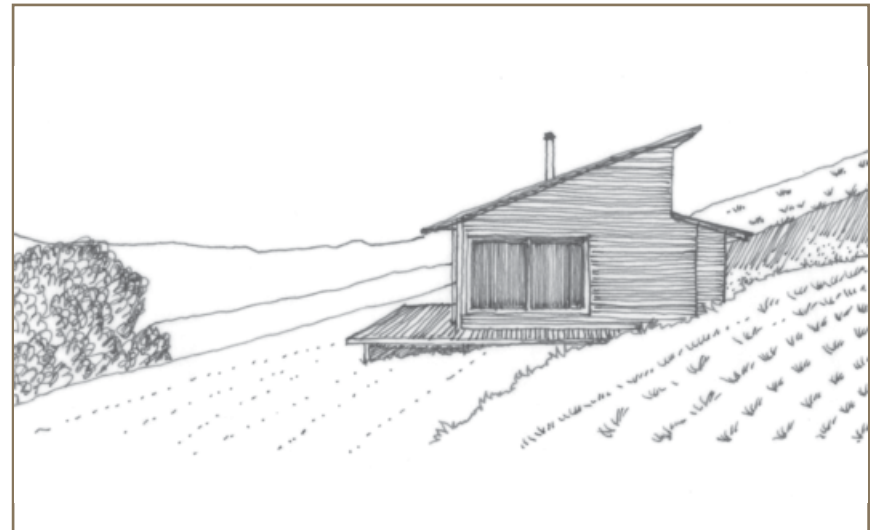

Contemporary single storey house recessed into the hillside

5. Design Guidance

5.33 (b) Layout

Layout is a critical consideration which if handled effectively, can contribute to a successful design solution. The key factors to be considered are:

Topography - development should take advantage of prevailing contours. For example split level designs suit sloping sites and create the effect of 'nestling' buildings into the topography.

Existing features - traditional boundaries, stone walls, hedging and field fences should be retained where possible. Woodland and tree cover should be retained and maximised if available and views should be taken advantage of without compromising privacy.

Established patterns of development - extensions to existing buildings or outbuildings should mirror established arrangements. For example, extensions to converted farm steadings or stables in country estates should reflect existing building footprints, plot patterns and should maintain spatial relationships between existing buildings in the group.

Existing man made or natural features - care should be taken in relation to positioning of new buildings with respect to proximity to established and protected features in the landscape - For example rivers, streams, canals, panoramic views, listed buildings and scheduled ancient monuments. Particular care is required in relation to location of enabling development and its impact on the setting of places of special architectural or historic significance.

Orientation - buildings should be positioned to maximise solar gain and natural shelter.

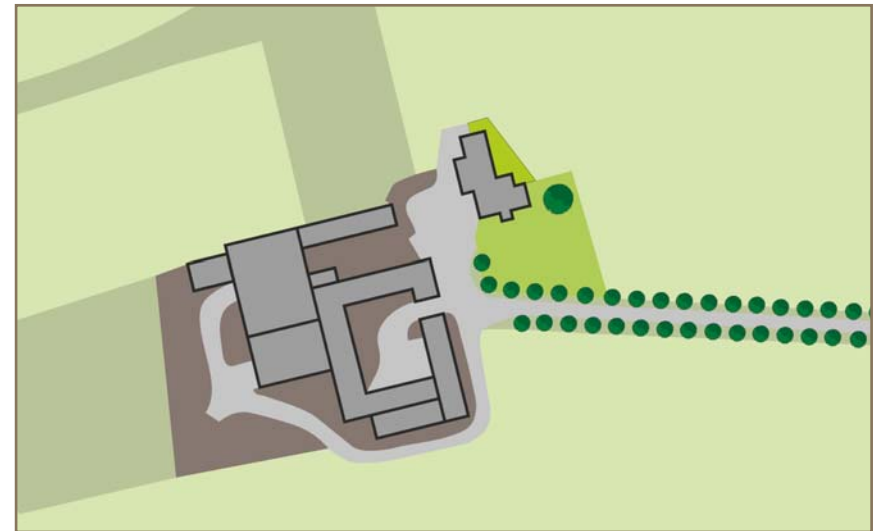

Arrangement of buildings in typical farm steading - farmhouse, barns and associated sheds are arranged to form inner courtyards. New development should respect established patterns.



Regular Urban Arrangement is inappropriate in a Rural Setting

5. Design Guidance

5.34 (c) Design

Local traditions, skills, materials and climatic conditions have influenced the design of buildings in the countryside in the past; for example natural stone and timber tended to be locally sourced. New development should respect key aspects of Falkirk's indigenous architecture and landscape in a contemporary manner to maintain a unique sense of place and to avoid 'anywhere' development. Originally designed, innovative and carefully sited buildings to fit the landscape using local materials will be encouraged.

5.35 Key design considerations for new development are :

5.36 Scale - New development in the countryside should be of a scale and density to fit with the surroundings. In the Falkirk Council area, traditional rural buildings are generally of compact scale and proportions. Storey heights rarely rise above two storeys and there is a low window to wall ratio with narrower gables and longer frontages. Farm steadings are generally of moderate scale and simple form in keeping with lowland farm traditions. Country estates are made up of assorted outbuildings, stables, walled gardens, lodge houses and follies, subservient in scale, style and complexity to the main house. Modern business and leisure developments including stables, holiday homes and agricultural buildings tend to be of moderate height with long elevations and shorter gables to accommodate functional requirements. Historic buildings and structures such as viaducts, doocots, castles and aqueducts are prominent in the landscape by virtue of their grand scale, location, quality of materials and unique design.

5.37 New development should reflect vernacular tradition with respect to simplicity of form and moderate height and width. Where large scale development is proposed, overall design, location and materials will be required to be highly sensitive to the context.



Traditional building carefully sited for natural shelter

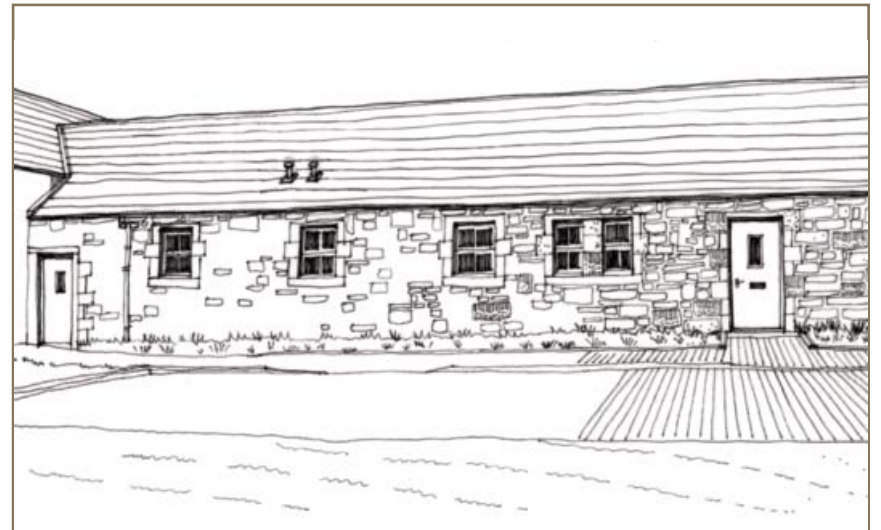

Low window to wall ratio is a common feature of traditional dwellings in the countryside

5. Design Guidance

- 5.38 Detailed Design** - In the Falkirk countryside, typical local detailing of buildings can be identified - see Section 5.19 of this Design guidance for examples of indigenous windows, rooflights, chimneys, roof verges and dormers.
- 5.39** New development will be required to demonstrate contemporary interpretation of established local detailing in an imaginative and creative manner to maintain visible links to the area to create individual designs and to avoid standardised 'anywhere' solutions.

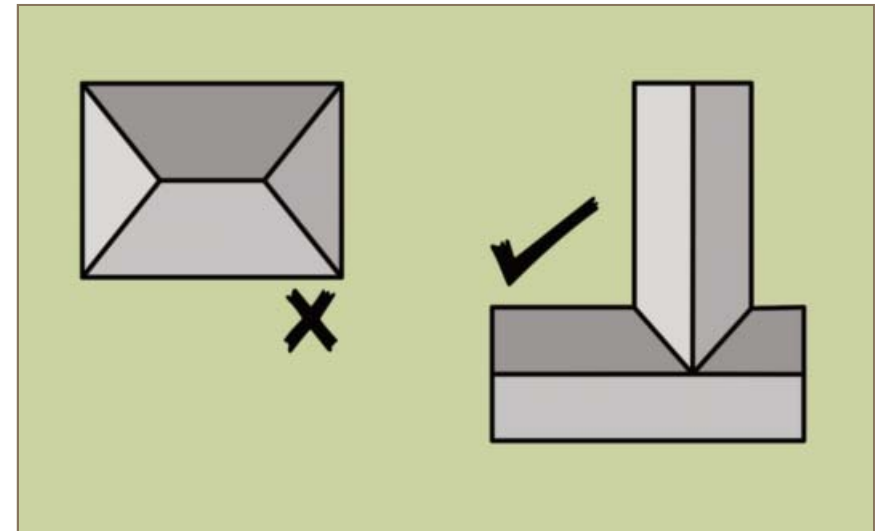

Traditional proportions such as linked rectangular plan forms as shown above are preferable to non-traditional deep plan/square plan forms. Pitched roofs are often incorporated creating symmetrical gables



Contemporary Interpretation of Traditionally Proportioned Dwellings
Copyright and Credits : Quercus Ltd., Pat and Andy law

5. Design Guidance

5.40 External Finishes - Traditionally, rural buildings were finished in stone, slate, timber, lime wash and lime harling. Locally sourced, natural materials should be applied to external walls and roofs of new development as much as is financially and practically possible to reflect local architectural traditions and to anchor the building into the landscape. The use of vividly coloured cladding systems and the application of artificial finishes such as render, plastic or upvc, metal and reconstituted stone should be avoided. The use of slate, natural stone and timber is encouraged.



5. Design Guidance

5.41 Sustainable Design - It is environmentally beneficial and sustainable to source materials locally; their use also helps to blend new buildings with the older more established buildings in the countryside. All development should be designed to be resilient to climate change through careful exterior detailing and choice of materials. Buildings should be positioned to maximise solar gain and to gain natural shelter from topographical features to reduce energy demands. Building design should aim for minimal carbon footprint from initial construction through to low energy use on a day to day basis. Re-use of existing buildings minimising loss of existing building components and materials is encouraged in cases of conversion and refurbishment. High performance, energy efficient glazing and innovative heating systems should be incorporated into new buildings.

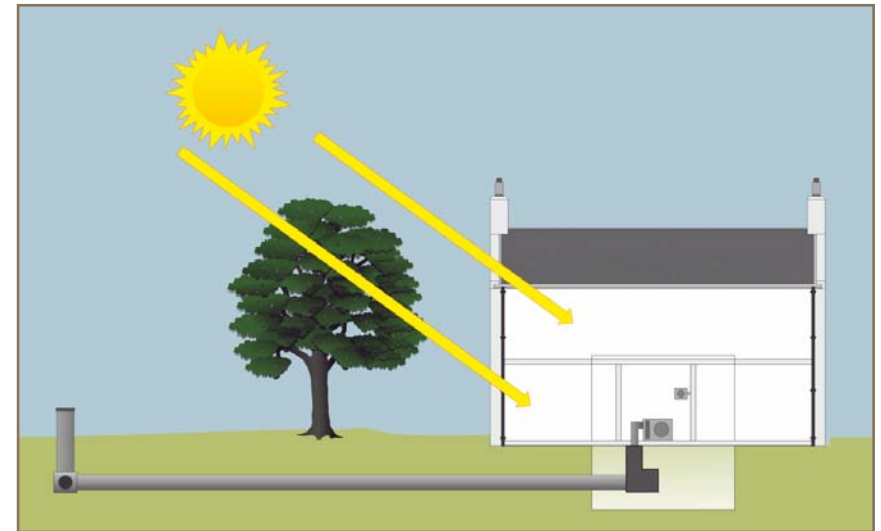

Buildings should be designed and orientated to take advantage of solar gain. High performance, energy efficient systems should be incorporated at initial design stages.

Windows to living spaces should be orientated to take advantage of solar gain and buildings should generally be situated to benefit from shelter from prevailing wind. Innovative low carbon heating systems such as ground source heat pumps as illustrated should be considered where conditions allow.



Grangewood Autonomous House
Copyright and Credits : Quercus Ltd.

5. Design Guidance

5.42 Boundary Treatments, Access and Parking - The design of boundary treatments, access roadways, hard standings for cars, gates and fences to new developments in the countryside should take into account the character and appearance of the surrounding landscape and should reflect the design of any indigenous detailing. Access roads should be positioned to allow the retention of existing boundaries such as stone field boundary walls, fences hedges and trees. The retention of existing features helps to integrate the building with its setting. In most cases simple low key designs using as few materials are preferable to complex and over sized grand designs. Urban solutions for walls and fencing using concrete and brick should be avoided. Access roads and parking areas should be designed to be as simple and informal as possible to integrate with existing roads using natural materials where possible. Safety standards should be accommodated without compromising rural character.



Simple, informal design reflects rural character

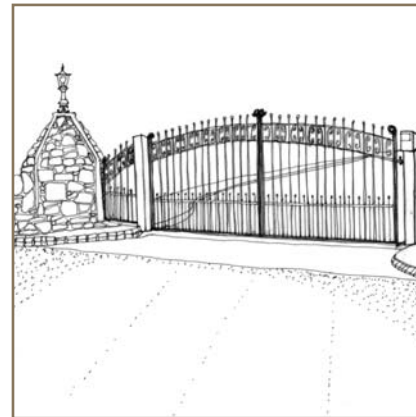

Inappropriate boundary treatments out of keeping with rural traditions

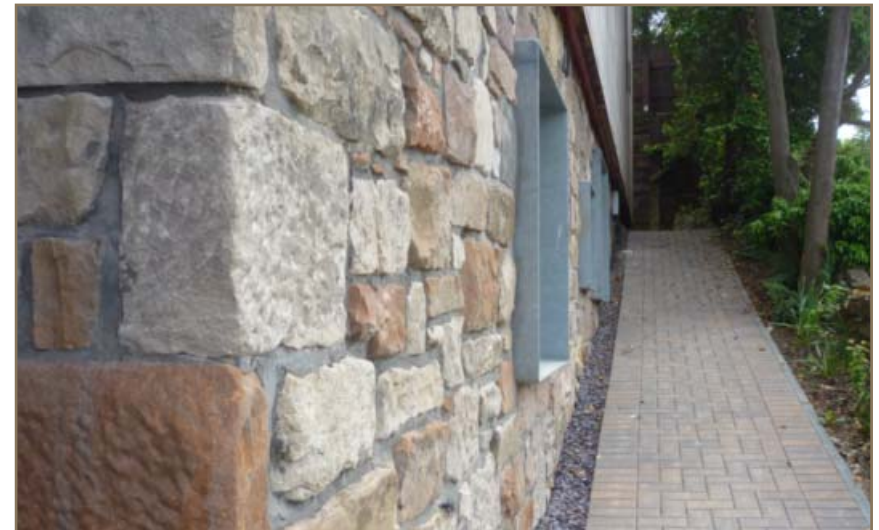

Sensitive choice of materials and crisp, simple detailing

5. Design Guidance

- 5.43 Landscaping** - Alterations to established landscape features and proposals for new landscaping associated with new development can have a major impact on both the immediate setting and the wider countryside area. Where a development site includes existing trees, hedgerows and other significant landscape features, they should be retained to restore and reinforce established rural character and appearance. Where existing landscape features are agreed to be removed, replacement with appropriate local species as advised by Falkirk Council's Landscape Officers should be agreed.
- 5.44** New planting including hedgerows and trees can provide effective screening as well as shelter from the elements on exposed sites. Where larger buildings are proposed, mitigating screen planting will be encouraged to reduce visual impact on the landscape. Screening and hedges planted with quick growing conifer species such as Cypress. Leylandii should be avoided in favour of appropriate native species.
- 5.45** Site analysis should include assessment of vantage points in the surrounding area from which new development will be visible. New landscaping features should be designed accordingly to create a natural fit between new buildings and rural setting.



Rural character is reinforced by simple treatments for hard and soft landscaping.

Copyright and Credits : The Pollock Hammond Partnership Architects and Conservation Consultants

5. Design Guidance

5.46 (d) Conversion of Existing Buildings

Due to industrial change, many buildings in the countryside of Falkirk are no longer suitable for their original purpose including mills, brickworks, farm steadings and buildings associated with water and transport systems. These buildings contribute to local distinctiveness and character. Older buildings can be successfully remodelled into contemporary living spaces without sacrificing traditional character. It is important that these buildings are not demolished unnecessarily or altered to such an extent that their significant features are lost. The total or substantial demolition of existing vernacular buildings will be discouraged unless supporting information is submitted to demonstrate :-

- 1). the existing building is incapable of repair and re-use as demonstrated by structural/engineering reports.
- 2). the costs of repair and re-use are such that it is not economically viable as demonstrated by full economic appraisal.



Vernacular buildings can be successfully remodelled and extended to provide contemporary living spaces without sacrificing traditional character

5. Design Guidance

5.47

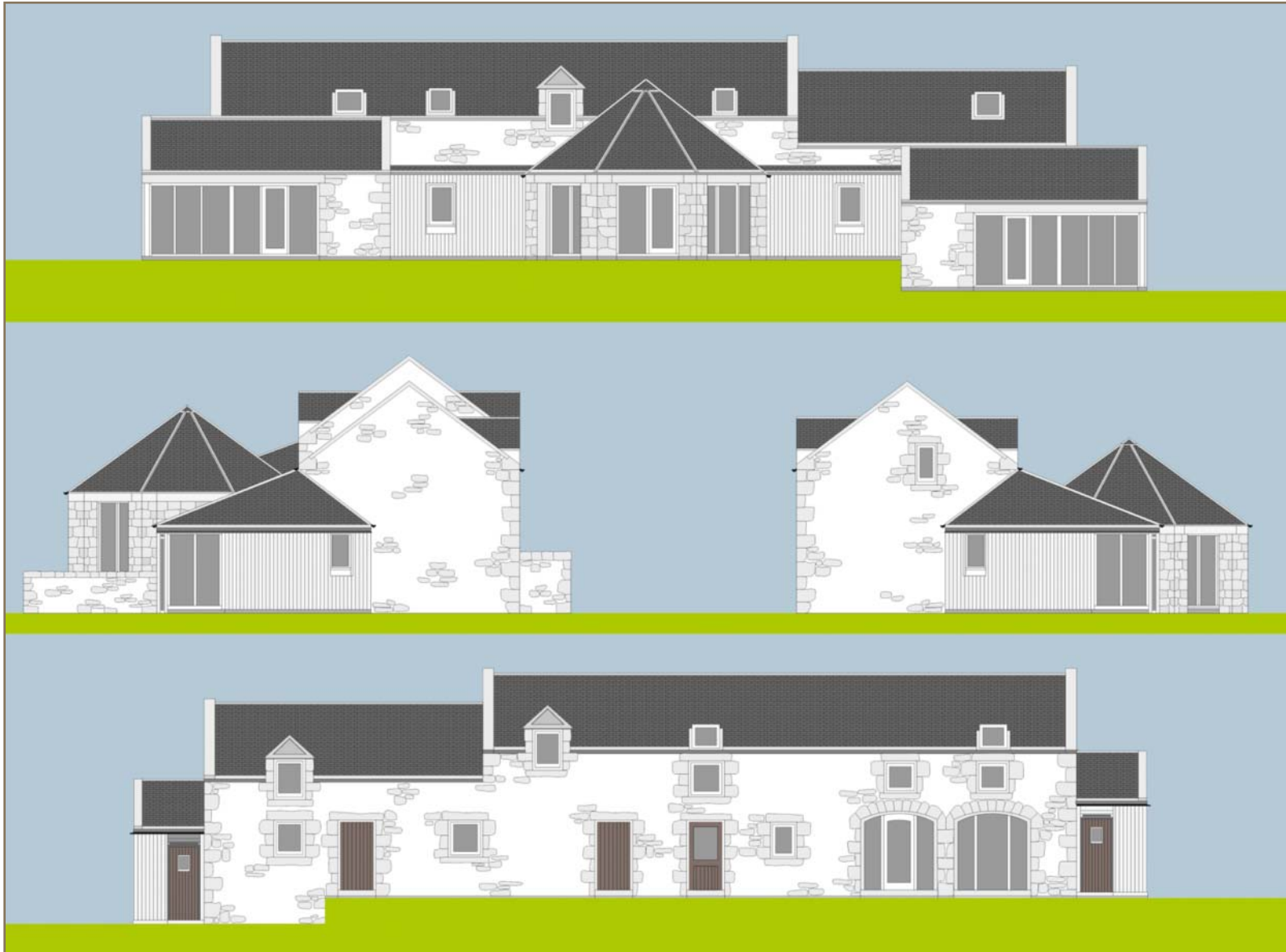

Case Study : North Mains, Beecraigs, by Linlithgow

Copyright and Credits : The Pollock Hammond Partnership Architects and Conservation Consultants

5. Design Guidance

5.48 (e) Infill Development

Infill development will only be acceptable where existing clusters of buildings are deemed to have capacity to accommodate new development without detriment to established patterns of development, character of the group and spatial relationships.

5.49 The introduction of modest development to small clusters of houses, and existing groups of buildings such as country estates and farm steadings must reflect the key characteristics of the existing group including building lines, scale, massing, orientation and existing access arrangements.

5.50 (iii) Enabling Development

Where enabling development is proposed to secure the long term future of a place of significant cultural or natural heritage, the resulting development should be of a high design quality. It should serve to protect the setting and special cultural or natural interest of the place and should represent the minimum level of development to enable the conservation of the place. Where new housing is proposed, great care should be applied to its location and design. If original elements of a designed landscape setting have survived, these should be integrated into proposals.

5.51 Enabling development will support the restoration of the main house in the Lathallan Estate converting it to 9 flats : other works include the demolition of the laundry, restoration and conversion of stables to form 3 houses and erection of 36 new houses. The new buildings will be unobtrusively sited in terms of views into the site from the surrounding roads owing to the heavily landscaped setting.



Lathallan House: Part elevation

5. Design Guidance

5.52



Lathallan Estate Site Plan showing enabling development within the estate

5. Design Guidance

5.53 The best examples of enabling development respond to the unique architectural and historic character of buildings and their settings by mitigating visual and physical impact on existing buildings and their setting and by enhancing special character. Enabling development at the Walled Garden of Tynninghame House took the form of small pavilions built up from the garden wall behind a 19th century greenhouse. The traditional design and materials preserve the character and appearance of the walled garden.



New Pavilions adjoining existing garden wall at Tynninghame House

© Crown Copyright reproduced courtesy of Historic Scotland
www.historicscotlandimages.gov.uk



Aerial View: Walled Garden at Tynninghame House

© Crown Copyright reproduced courtesy of Historic Scotland
www.historicscotlandimages.gov.uk

5. Design Guidance

5.54 Design Principles Checklist

Location	The impact of larger buildings should be minimised through siting, landscaping, massing and use of colour and all new development should take advantage of existing features and topography to effect an “nestling effect” within the rural landscape.
Layout	New development should be orientated to take advantage of natural shelter and solar gain and should respect and retain existing site features such as boundaries, walls, woodland and trees. Where extensions to existing groups of buildings are proposed, interventions should mirror established development patterns including footprints, plot patterns and spatial relationships between buildings.
Design	Originally designed, innovative buildings that fit the local landscape using local, natural materials will be encouraged.
Scale	New development should be of a scale and density to fit with the surroundings. Reference should be taken from local vernacular building tradition of simple forms and moderate height and width.
Detailed Design	Contemporary interpretation of the architectural detailing of local vernacular buildings will be encouraged - take reference from traditional windows, rooflights, doors, chimneys, roof verges etc.
External Finishes	The use of natural building materials will be encouraged - e.g. stone, slate, timber, harling.
Sustainable Design	Use locally sourced and recycled / salvaged building materials wherever possible and design new development to maximise energy efficient and to withstand the impacts of climate change. Position new buildings to take advantage of solar gain and natural shelter.
Boundary Treatments, Access and Parking	The design of boundary treatments, access and parking should reflect local character and materials; simple low key designs using natural materials are preferable to complex, over - size solutions more suited to an urban setting.
Landscaping	Existing landscape features should be retained; new planting can provide shelter and can mitigate the visual impact of larger buildings.
Conversion of Existing Buildings	Traditional rural buildings should be retained and remodelled as required to provide contemporary uses and to maintain local distinctiveness and character. Total or substantial demolition will be discouraged.
Infill Development	Limited development - up to 3 houses - will only be acceptable where it has no impact on the character of established clusters of buildings.
Enabling Development	Enabling development will only be encouraged where it secures the long term future of a significant place via development of high design quality which protects the setting and special cultural or natural interest of the place.

Please Refer to pages 33 - 45 for Detailed Guidance

Appendix 1 - List of relevant Local Development Plan Policies

6.1 List of relevant Local Development Plan Policies (found within Supporting Policies Chapter)

Policy	Topic
Policy INF02	Developer Contributions to Community Infrastructure
Policy INF07	Walking and Cycling
Policy INF10	Transport Assessments
Policy INF12	Water and Drainage Infrastructure
Policy BUS01	Business and Tourism
Policy BUS05	Major Hazards and Pipelines
Policy GN02	Landscape
Policy GN03	Biodiversity and Geodiversity
Policy GN04	Trees, Woodland and Hedgerows
Policy GN05	Outdoor Access
Policy D02	Sustainable Design Principles
Policy D04	Low and Zero Carbon Development
Policy D07	Antonine Wall
Policy D08	Sites of Archaeological Interest
Policy D09	Listed Buildings
Policy D12	Historic Gardens and Design Landscapes
Policy D13	Battlefield Sites
Policy RW04	Agricultural Land, Carbon Rich Soils and Rare Soils
Policy RW06	Flooding
Policy RW07	Air Quality
Policy RW09	Waste Reduction in New Development
Policy RW10	Vacant Derelict and Contaminated Land
Policy HSG05	Infill Development and Subdivision of Plots
Policy HSG07	House Extensions and Alterations
Policy HSG08	Gypsy/Traveller Sites

Appendix 2 - Useful Contacts

6.2 Information on Planning Permission, Permitted Development, Listed Building and Conservation Area control can be obtained from:

Development Management

Development Services
Falkirk Council
Abbotsford House
David's Loan
Falkirk FK2 7YZ
Tel: 01324 504748
Email: dc@falkirk.gov.uk

Building Warrant information can be obtained from:

Building Standards

Development Services
Falkirk Council
Abbotsford House
David's Loan
Falkirk
FK2 7YZ
Tel. 01324 504985
Email: buildingcontrol@falkirk.gov.uk

Information on Roads Construction Consent can be obtained from:

Roads and Development

Development Services
Falkirk Council
Abbotsford House
David's Loan
Falkirk
FK2 7YZ
Tel. 01324 504950
Email: roads@falkirk.gov.uk

A list of architects and advice on employing a Chartered Architect can be obtained from:

The Royal Incorporation of Architects in Scotland (RIAS)

15 Rutland Square
Edinburgh
EH1 2BE
Tel. 0131 229 7545
Email: info@rias.org.uk
Helpful information also available on the RIAS website: www.rias.org.uk

Information on protected species can be obtained from:

Scottish Natural Heritage (SNH)

Forth Region
Silvan House
3rd Floor East
231 Corstorphine Road
Edinburgh
EH12 7AT
Tel. 0131 316 2600
Email: forth@snh.gov.uk

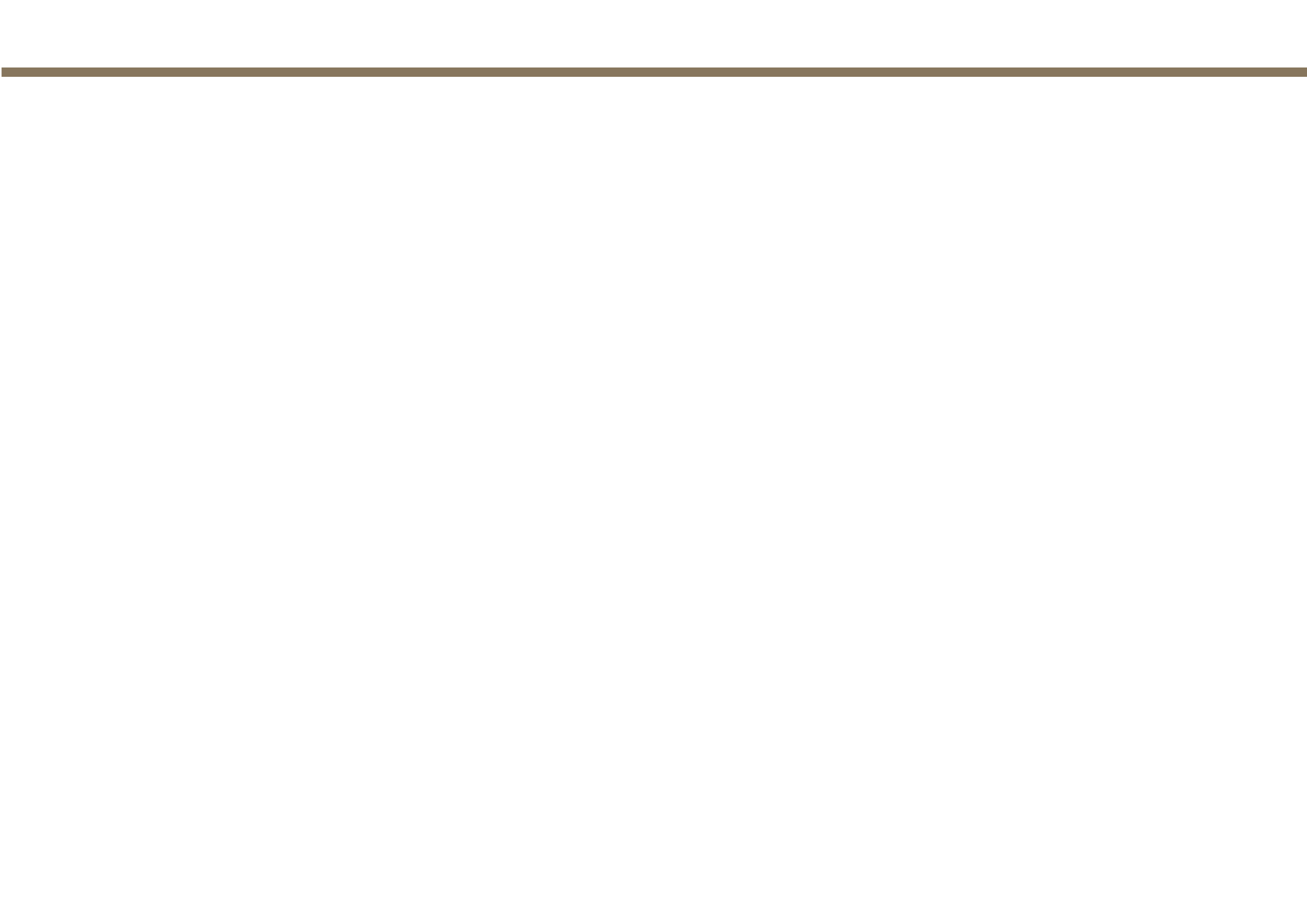

Supplementary Guidance SG01

July 2015



Falkirk Council
Development Services